

PROGRAMMABLE CURRENT SENSING HIGH SIDE SWITCH

Features

- Load current feedback
- Programmable over current shutdown
- Active clamp
- E.S.D protection
- Input referenced to Vcc
- Over temperature shutdown
- Reverse battery protection

Description

The IR 3310 is a Fully Protected 4 terminal high side switch. The input signal is referenced to Vcc. When the input voltage Vcc - Vin is higher than the specified Vih threshold, the output power MOSFET is turned-on. When Vcc - Vin is lower than the specified Vil threshold, the output MOSFET is turned-off. A sense current proportional to the current in the power Mosfet is sourced to the Ifb pin. Over-current shutdown occurs when Vifb - Vin > 4 V. The current shutdown threshold is adjusted by selecting the proper RIfb. Either over-current and over-temperature latches off the switch. The device is reset by pulling the input pin high. Other integrated protections (ESD, reverse battery, active clamp) make the IR 3310 very rugged and suitable for the automotive environment.

Product Summary

R _{ds(on)}	7mΩ max.
V _{cc.op.}	6 to 28V
Current ratio	8800
I _{shutdown}	10 to 100A
Active clamp	35V
Load Dump Max.	43V

Package

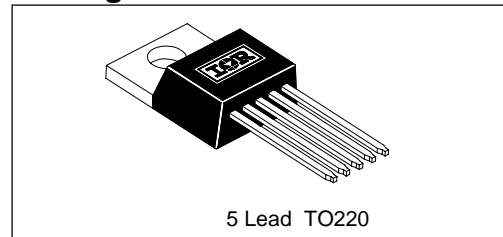

Typical Connection

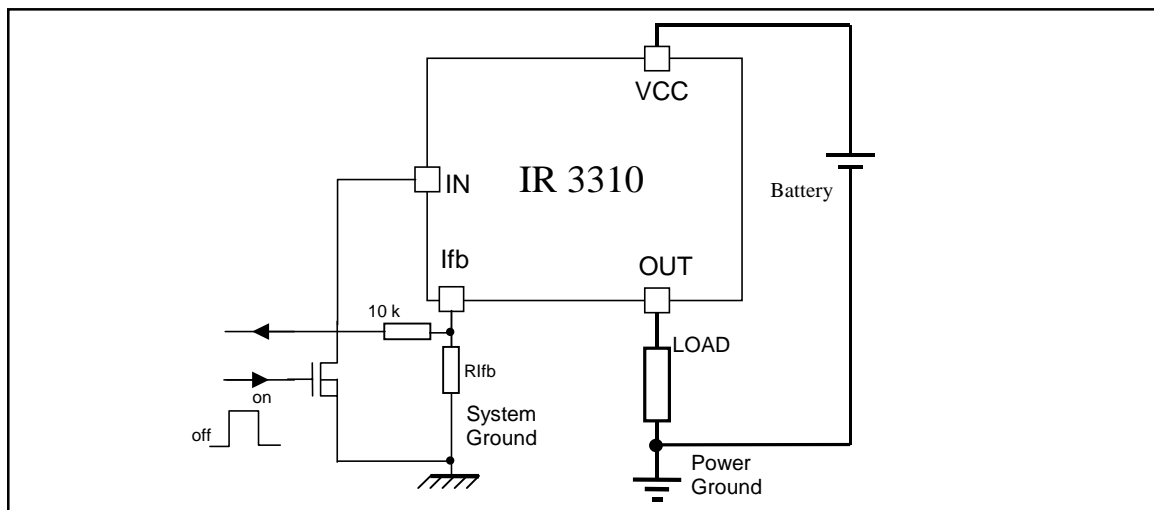

Absolute Maximum Ratings

Absolute maximum ratings indicate sustained limits beyond which damage to the device may occur. All voltage parameters are referenced to Vcc lead. (T_{Ambient} = 25°C unless otherwise specified).

Symbol	Parameter	Min.	Max.	Units
V _{cc} - V _{in} max	Maximum input voltage	-16	50	V
V _{cc} -V _{lfb} max	Maximum lfb voltage	-0.3	50	
V _{cc} - V _{out} max.	Maximum output voltage	-0.3	30	
I _{ds} cont.	Diode max. permanent current (R _{th} = 60 °C/W) (1)	—	2.8	A
I _{ds1} cont	Diode max. permanent current (R _{th} = 5 °C/W) (1)	—	35	
I _{ds} pulsed	Diode max. pulsed current (1)	—	100	
ESD 1	Electrostatic discharge (human body model)	—	4	kV
ESD 2	Electrostatic discharge (machine model)	—	0.5	
P _d	Power dissipation (R _{th} = 60 °C/W)	—	2	W
T _J max.	Max. storage and junction temperature	-40	150	°C
Min R _{lfb}	Minimum resistor on the lfb pin	0.3	—	kΩ
I _{fb} max	Max. lfb current	-20	+20	mA

Thermal Characteristics

Symbol	Parameter	Typ.	Max.	Units
R _{th} free air	Thermal resistance - free air	60	—	°C/W
R _{th} junct. to case	Thermal resistance junction to case	0.7	—	°C/W

Recommended Operating Conditions

These values are given for a quick design. For operation outside these conditions, please consult the application notes.

Symbol	Parameter	Min.	Max.	Units
V _{cc} -V _{in}	Continuous input voltage	6	28	V
V _{cc} -V _{lfb}	Continuous lfb pin voltage	0.3	28	
V _{cc}	Supply to power ground voltage	6	28	
I _{out}	Continuous output current (R _{th} /amb < 5 °C/W, T _j = 125°C)	—	35	A
I _{out} 85°C amb.	Continuous output current (R _{th} /amb < 60 °C/W, T _j = 125°C)	—	6.5	
R _{lfb}	lfb resistor to program I _{sd} and scale (2 & 3)	0.5	3.5	kΩ
Pulse min.	Minimum turn-on pulse width	1	—	ms
F _{max}	Maximum operating frequency	—	500	Hz
F _{max} Prot.	Maximum frequency with protections activated	—	200	

- 1) Limited by junction temperature. Pulsed current is also limited by wiring
- 2) <500 Ohm or shorting lfb to gnd may damage the part with I_{sd} around 120A
- 3) >5000 Ohm or leaving lfb open will shutdown the part. No current will flow in the load.

Protection Characteristics

$T_j = 25^\circ\text{C}$ (unless otherwise specified), $R_{lfb} = 500$ to $5\text{k}\Omega$.

Symbol	Parameter	Min.	Typ.	Max.	Units	Test Conditions
$V_{lfb} - V_{in}$ @ I_{sd}	Over-current shutdown threshold	4	4.5	5.4	V	
T_{sd}	Over-temp. shutdown threshold	—	165	—	$^\circ\text{C}$	see Fig. 7
T_{reset}	Protection reset time	—	50	300	mS	see Fig. 7
OV	Over voltage shutdown (not latched)	30	33	37	V	
I_{sdf}	Fixed over current shutdown	100	120	140	A	$V_{lfb} < V_{in}$
I_{sd_1k}	Adjustable over current shutdown 1K	30	40	50	A	$R_{lfb} = 1\text{k}$
Min.Pulse	Minimum pulse width (no WAIT state)	200	500	1200	μs	see Fig. 6
WAIT	WAIT function timer	0.5	1.2	3.5	ms	see Figs. 6 and 7
$Rev.Rds_{on}$	$R_{ds(on)}$ reverse battery protection	4	6.2	10	$\text{m}\Omega$	$V_{cc} - V_{in} = -12\text{V}$, $R_{load} = 0.5\Omega$

Static Electrical Characteristics

($T_j = 25^\circ\text{C}$, $V_{cc} = 14\text{V}$ unless otherwise specified.)

Symbol	Parameter	Min.	Typ.	Max.	Units	Test Conditions
I_q	Total quiescent current ($I_{out} + I_{fb}$)	—	22	50	μA	$V_{cc} - V_{in} = 0$, $V_{cc} - V_{out} = 12\text{V}$ $V_{cc} - V_{lfb} = 12\text{V}$
I_{in}	Input current	2	4	8	mA	$V_{cc} - V_{in} = 14\text{V}$
V_{ih}	High level input threshold voltage (4)	—	5	5.5	V	
V_{il}	Low level input threshold voltage (4)	3.5	4	—		
V_{hys}	Input hysteresis = $V_{ih} - V_{il}$	0.4	1	1.5		
$I_{out\ qs}$	Output quiescent current	—	9	15	μA	$V_{cc} - V_{in} = 0$; $V_{cc} - V_{lfb} = 0$; $V_{cc} - V_{out} = 12\text{V}$
$R_{ds1\ on}$	ON state resistance (5)	4	5.5	7	$\text{m}\Omega$	$I_{out} = 30\text{A}$, $V_{cc} - V_{in} = 14\text{V}$
$R_{ds2\ on}$	ON state resistance (5)	4	5.7	10		$I_{out} = 17\text{A}$, $V_{cc} - V_{in} = 6\text{V}$
$R_{ds3\ on}$	ON state resistance (5)	7	12	15		$I_{out} = 30\text{A}$, $T_j = 150^\circ\text{C}$
V_{clamp1}	V_{cc} to V_{out} active clamp voltage	30	35	—	V	$I_{out} = 10\text{mA}$
V_{clamp2}	V_{cc} to V_{out} active clamp voltage	—	36	40		$I_{out} = 30\text{A}$, $V_{cc} - V_{lfb} < 20\text{V}$
V_{sd}	Body diode forward voltage	—	0.85	1		$I_{out} = 30\text{A}$
$V_{aval.}$	V_{cc} to V_{out} avalanche voltage	40	43	50		$I_{out} = 30\text{A}$, $V_{cc} - V_{lfb} > 35\text{V}$

Switching Electrical Characteristics

$V_{cc} = 14\text{V}$, Resistive Load = 0.4Ω , $T_j = 25^\circ\text{C}$, (unless otherwise specified).

Symbol	Parameter	Min.	Typ.	Max.	Units	Test Conditions
T_{don}	Turn-on delay time to $V_{cc} - V_{out} = 0.9 V_{cc}$	1	8	30	μs	see figure 2
T_{r1}	Rise time to $V_{cc} - V_{out} = 5\text{V}$	0.4	2	10		
T_{r2}	Rise time to $V_{cc} - V_{out} = 0.1 V_{cc}$	10	30	100		
E_{on}	Turn ON energy	—	3	6	mJ	see figure 3
T_{doff}	Turn-off delay to $V_{cc} - V_{out} = 0.1 V_{cc}$	10	30	100	μs	
T_f	Fall time to $V_{cc} - V_{out} = 0.9 V_{cc}$	—	15	—		
E_{off}	Turn OFF energy	—	2	4	mJ	

4) Input threshold are measured directly between the input pin and the tab. Any parasitic resistance in common between the load current path and the input signal path can significantly affect the thresholds.

5) $R_{ds(on)}$ is measured between the Tab and the Out pin, 5mm away from the package.

Current Sense Characteristics

Symbol	Parameter	Min.	Typ.	Max.	Units	Test Conditions
Ratio	I load / I _{fb} current ratio	7,500	8,800	10,000	—	T _j = 25°C, R _{lfb} = 300Ω, I = 60A
Ratio_TC	I _{load} /I _{fb} variation over temperature	-5	0	+5	%	T _j = 40 To +150°C
offset	Load current diagnostic offset	-1.3	0	+1.3	A	I = 2A
Trst	I _{fb} response time (low signal)	—	5	15	μs	90% of the I load step

Functional Block Diagram

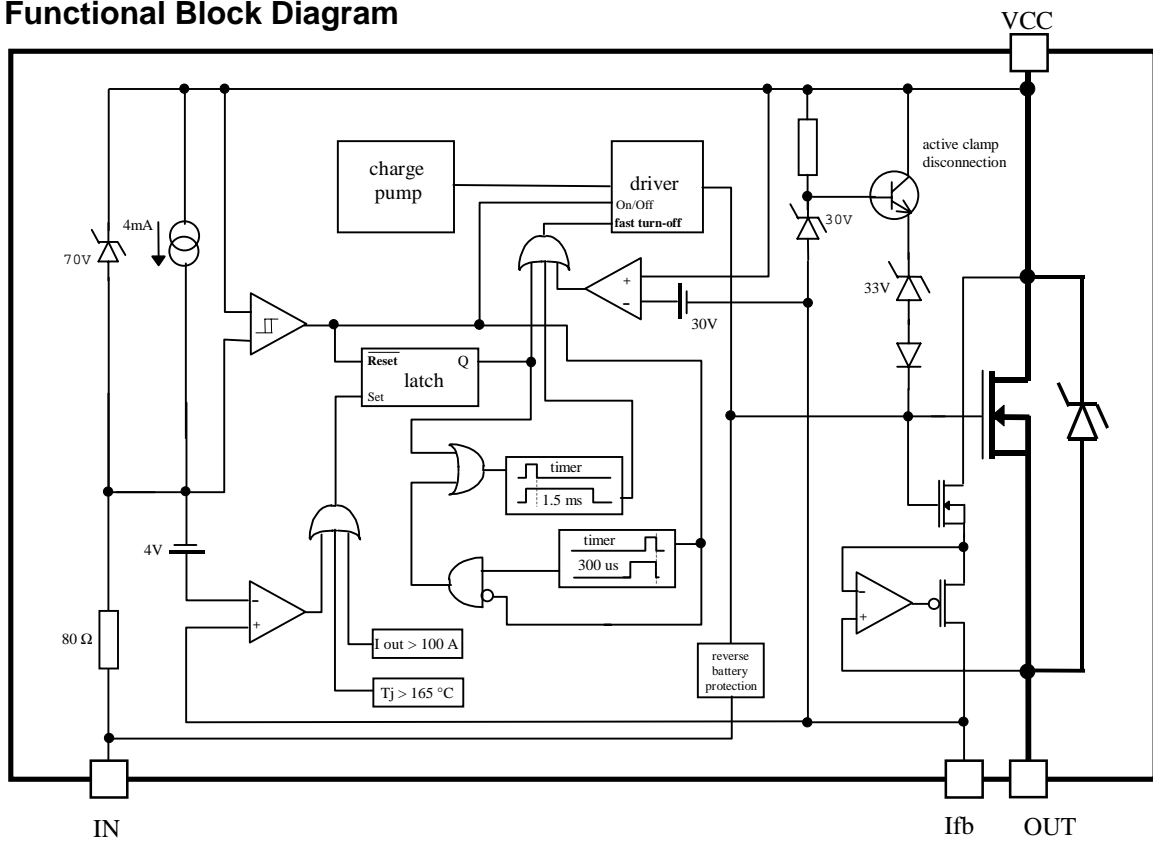

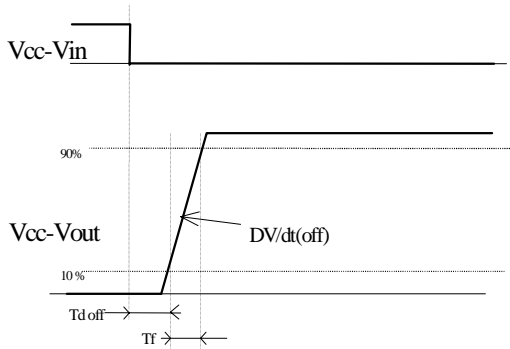

Figure 3 - Switching time definitions (turn-off)

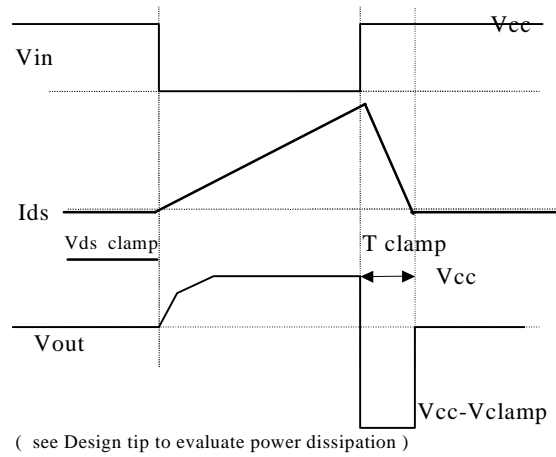
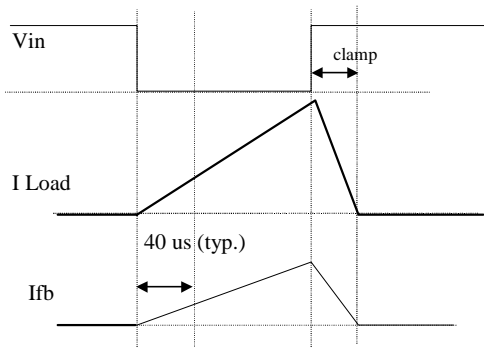

Figure 4 - Active clamp waveforms



Precise measurement

Figure 5 - Current sense precision:
Accurate measurement only when the power Mosfet is fully ON

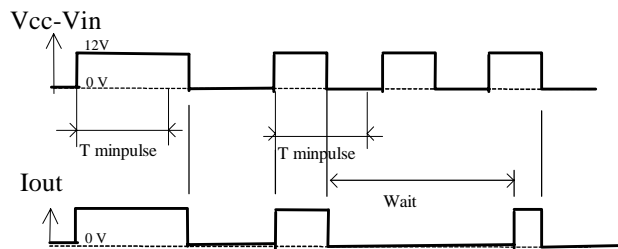

Figure 6 - Minimum pulse & WAIT function

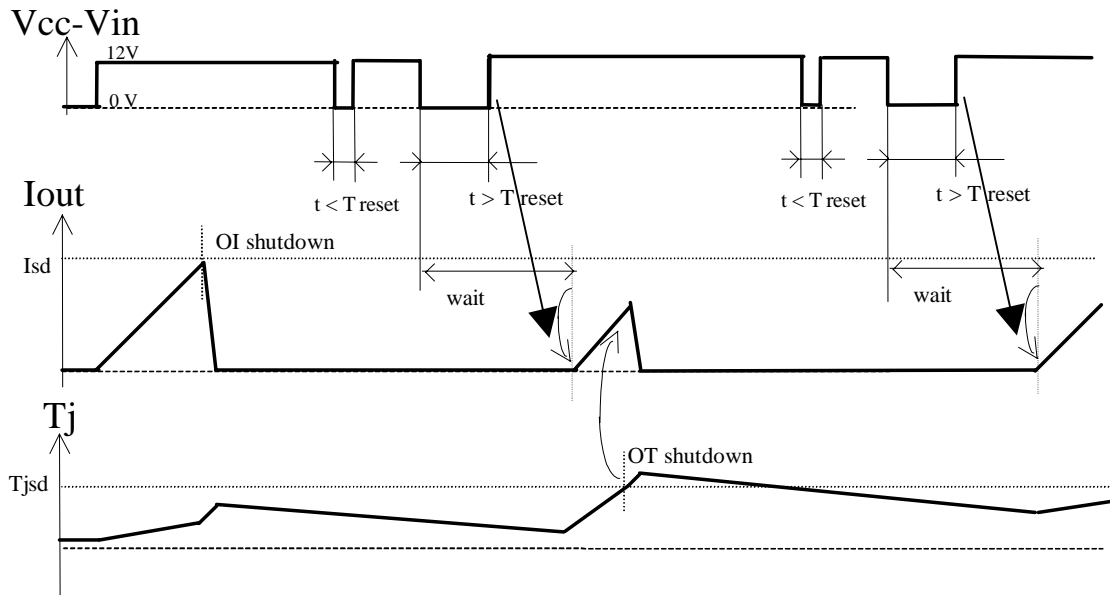

Figure 7 - Protection Timing Diagrams

All curves are typical characteristics. Operation in hatched areas is not recommended. $T_j=25^{\circ}\text{C}$, $R_{\text{th}}=500\ \Omega$, $V_{\text{CC}}=14\text{V}$ (unless otherwise specified).

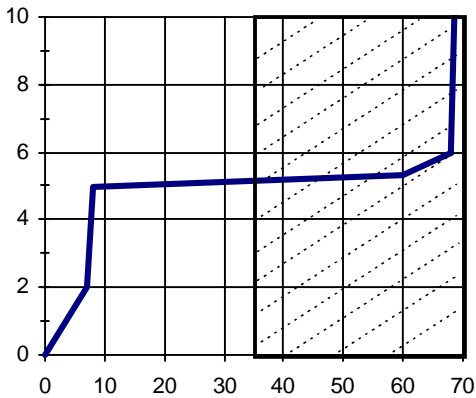

Figure 8 - I_{CC} (mA) vs $V_{\text{CC}}-V_{\text{in}}$ (V)

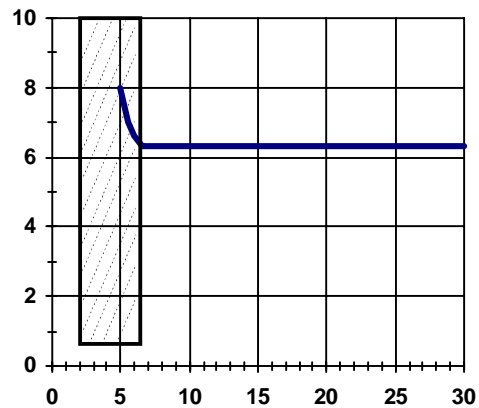

Figure 9- $R_{\text{DS(on)}}$ ($\text{m}\Omega$) vs $V_{\text{CC}}-V_{\text{in}}$ (V)

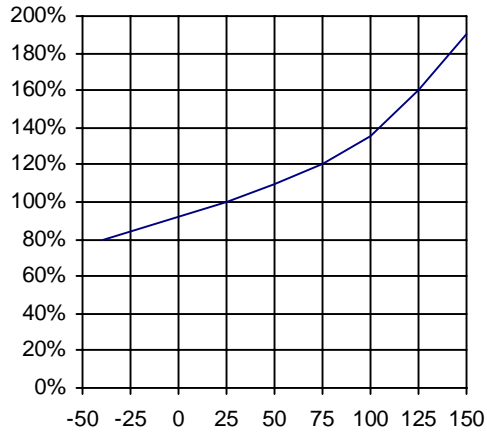

Figure 10 - Normalized Rdson (%) vs Tj (°C)

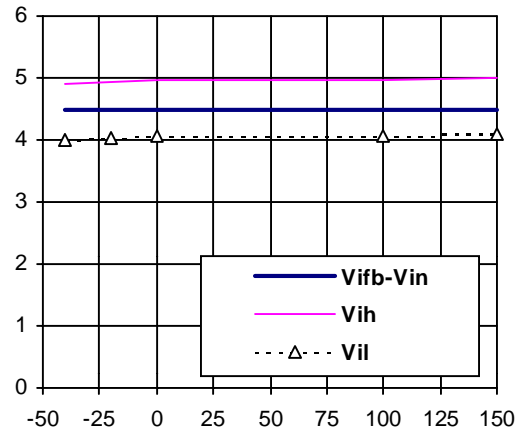

Figure 11 - Vih, Vil & Vfb -Vin (V) vs Tj (°C)

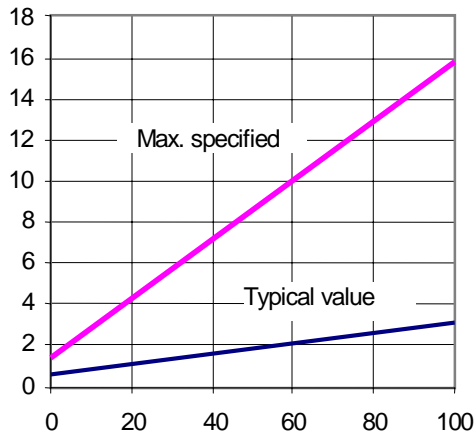

Figure 12 - Error (+/-A) vs Iload (A)

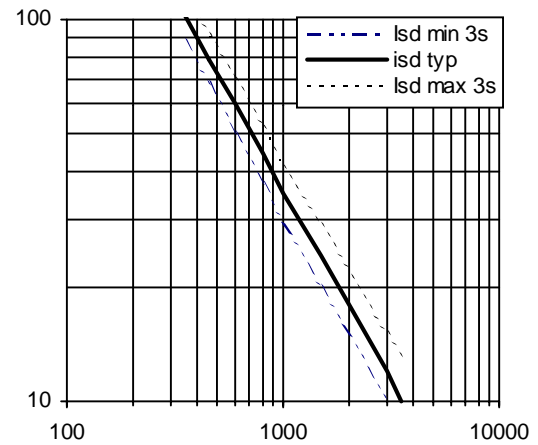

Figure 13 - Isd (A) vs Rlfb (Ohm)

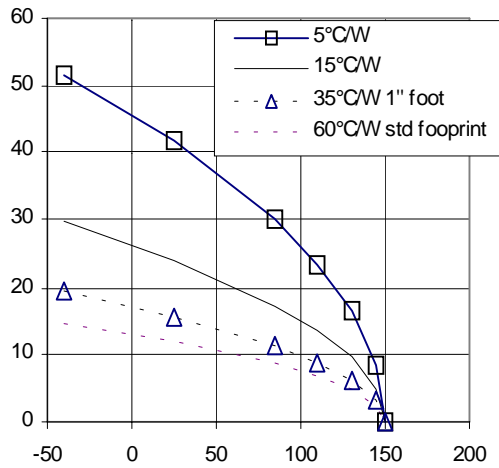

Figure 14 - Max. DC current (A) vs Temp. (°C)

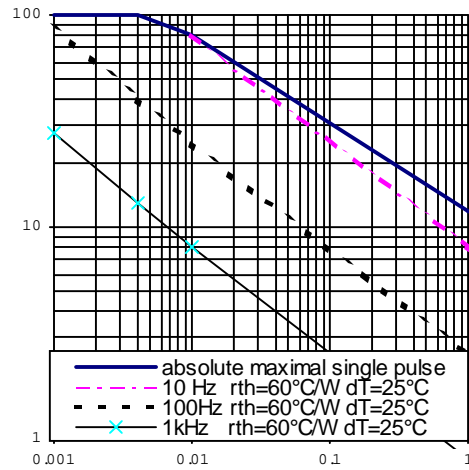

Figure 15 - Max. I (A) vs inductance (mH)

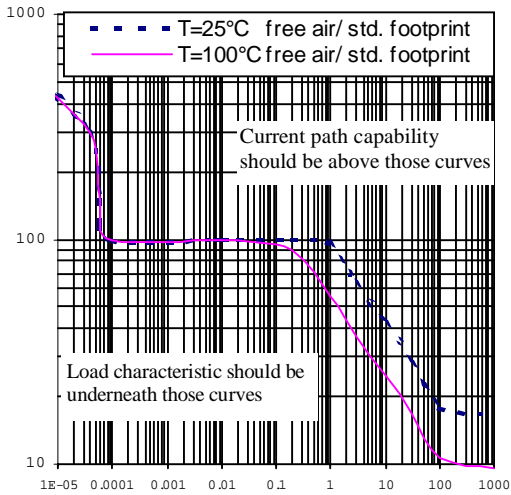

Figure 16 - I out (A) vs Protection resp. Time (s)

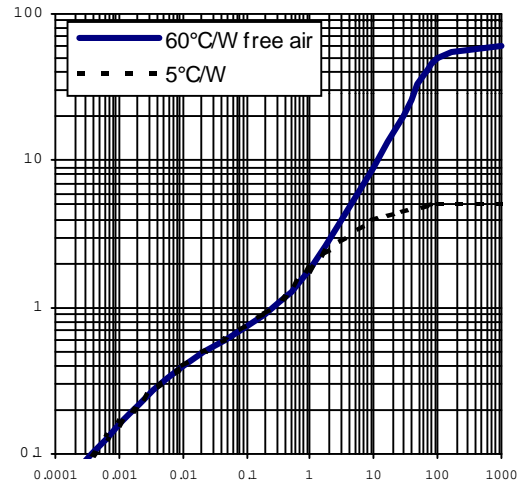

Figure 17 - Rth (°C/W) vs Time (s)

Case Outline - TO220 (5 lead)

